



CONFIGURATION GUIDE

JMG MAGNETIC LEVEL GAUGE & JXC EXTERNAL CHAMBER

Features, Benefits, Options:

- Extra Wide Indicator Available
- Clear Visibility to 200 feet
- No fluid in contact with glass
- Rugged, safe and low maintenance
- Wide range of materials
- Pressures from FV to 5000 psig
- Temperatures from -320°F to 1000°F
- Fluid SG as low as 0.25
- Interface Δ SG as low as .025
- Length to 40 feet
- Designed to ASME B31.3 or B31.1
- Code welding in house
- Magnetostrictive Transmitter Option
- Multiple switch options
- High Temp and Cryogenic Insulation

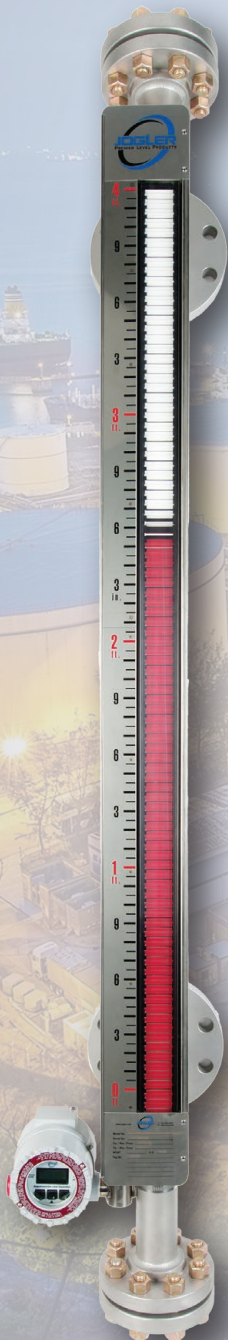



HOW TO ORDER

For a quote on a JMG magnetic level gauge or a JXC external chamber fill out the appropriate spec sheet below and email it to inquiries@jogler.com or to your local Jogler representative. Jogler will configure the model number and provide pricing. You can also build the model number using the Model Number Guide and email it along with the “Service Conditions” information required on the appropriate spec sheet.

Click [here](#) to view the Magnetic Level Gauge – Side Mounted spec sheet.

Click [here](#) to view the Magnetic Level Gauge – Top Mounted spec sheet.

Click [here](#) to view the External Chamber for Direct Insertion Transmitter or Switch spec sheet.

MODEL NUMBER GUIDE

JMG Magnetic Level Gauge and JXC External Chamber

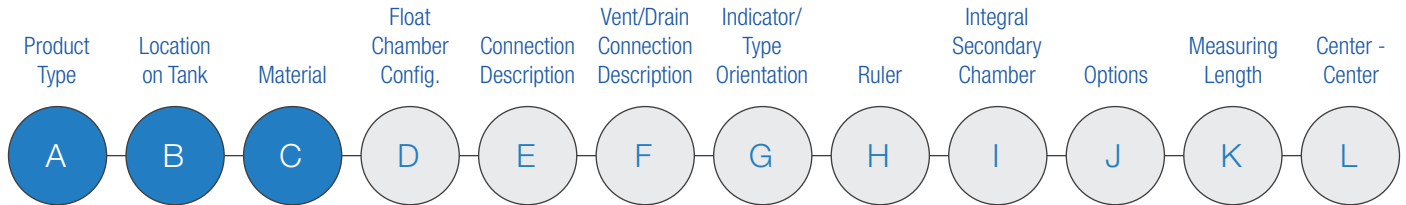

A | Product type

JMG	Magnetic level gauge
JXC	External chamber for direct insertion transmitter or switch

B | Location on tank

Blank	Leave blank for JXC external chamber
S	Mounted on side of tank
T	Mounted on top of tank
B	Mounted on bottom of tank

C | Material of Construction

CS	Carbon steel (JXC only)
4S	304/304L SS chamber and flanges
4C	304/304L SS chamber with A105 carbon steel flanges
6S	316/316L SS chamber and flanges
6C	316/316L SS chamber with A105 carbon steel flanges
1S	321 SS chamber and flanges
1C	321 SS chamber with A105 carbon steel flanges
7S	347 SS chamber and flanges
7C	347 SS chamber with A105 carbon steel flanges
9L	904L SS
A2	Alloy 20
HC	Hastelloy C-276
HCC	Hastelloy C-276 with A105 carbon steel LJ flanges
HB	Hastelloy B2/B3 ¹
IN60	Incoloy 600
IN62	Incoloy 625
IN80	Incoloy 800
IN82	Incoloy 825
AL	Aluminum
T2	Titanium Grade 2
ZR	Zirconium 702

4T	304/304L SS chamber with Teflon S internal coating for slip resistance ²	450°F max.
6T	316/316L SS chamber with Teflon S internal coating for slip resistance ²	450°F max.
4H	304/304L SS chamber with Halar internal coating for corrosion resistance ³	300°F max.
6H	316/316L SS chamber with Halar internal coating for corrosion resistance ³	300°F max.
4Z	304/304L SS chamber with Tefzel internal coating for corrosion resistance ³	300°F max.
6Z	316/316L SS chamber with Tefzel internal coating for corrosion resistance ³	300°F max.
4P	304/304L SS chamber with PFA internal coating for corrosion resistance ³	400°F max.
6P	316/316L SS chamber with PFA internal coating for corrosion resistance ³	400°F max.
PV	PVC ⁴	0 to 140°F, 50 psig max
CP	CPVC ⁴	0 to 200°F, 50 psig max
PE	Polyethylene ⁵	-40 to 140°F, 50 psig max
PP	Polypropylene ⁴	35 to 200°F, 50 psig max
KY	Kynar (PVDF) ⁵	-40 to 280°F, 50 psig max
EP	Epoxy Resin Fiberglass ⁵	-20 to 175°F, 50 psig max
VE	Vinyl Ester Resin Fiberglass ⁵	-20 to 175°F, 50 psig max

Notes:

- Parts fabricated from bar may be B2 due to availability. All other parts will be B3.
- Maximum measuring length is 20'. Must have flanges on top and bottom of float chamber. Minimum process connection size is 2".
- Maximum measuring length is 16'. Must have flanges on top and bottom of float chamber. Minimum process connection size is 2". No threaded vent and drain connections. 3/4" minimum vent and drain flange size.
- Maximum measuring length is 40'.
- Maximum measuring length is 18'.
- Custom specify size and material.

MODEL NUMBER GUIDE

JMG Magnetic Level Gauge and JXC External Chamber

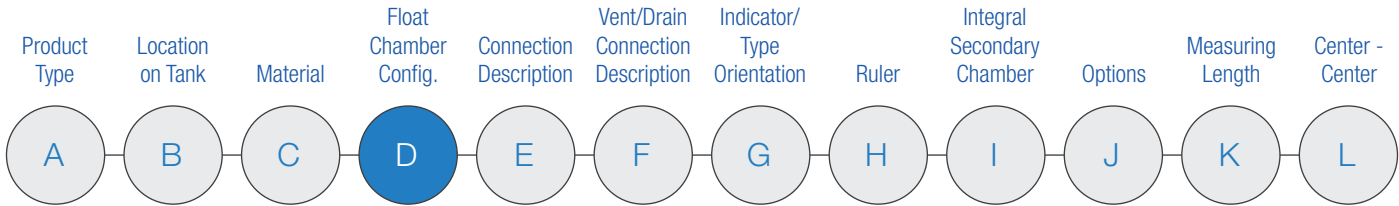

D | Float chamber configuration: Top code, Top/Side Code, Bottom/Side Code, Bottom Code (see pg. 9 for examples)

Side mounted float chamber top and bottom option codes	
P0	Welded flat pipe cap ²
P1	Flat pipe cap with FNPT ²
P2	Flat pipe cap with FNPT and hex plug ²
P3	Flat pipe cap with female socket ²
P4	Flat pipe cap with MNPT nipple ²
P5	Flat pipe cap with flat end nipple for socket welding ²
P6	Flat pipe cap with beveled nipple for butt welding ²
P7	Flat pipe cap with nipple and flange ²
B0	Butt weld pipe cap
B1	Butt weld pipe cap with FNPT half coupling
B2	Butt weld pipe cap with FNPT half coupling and plug
B3	Butt weld pipe cap with SW half coupling
B4	Butt weld pipe cap with MNPT nipple
B5	Butt weld pipe cap with flat end nipple for socket welding
B6	Butt pipe cap with beveled nipple for butt welding
B7	Butt weld pipe cap with nipple and flange
B8	Concentric reducer with flange
F	Flange
F0	Flange with mating blind flange
F1	Flange with mating blind flange with FNPT
F2	Flange with mating blind flange with FNPT and hex plug
F3	Flange with mating blind flange w/ female socket
F4	Flange with mating blind flange w/ MNPT nipple
F5	Flange with mating blind flange w/ flat end nipple for socket welding
F6	Flange with mating blind flange w/ beveled nipple for butt welding
F7	Flange with mating blind flange w/ reduced size vent/drain flange and nipple
C	Custom (Describe or provide drawing)

Side mounted float chamber side connection option codes	
X	No side connection
FE	Flange welded to extruded outlet ³
FP	Flange with pipe between flange and chamber ⁴
FW	Flange with weld-o-let ⁵
FT	Flange with butt weld tee in float chamber ⁶
FC	Flange with concentric reducer ⁷
NTE	MNPT nipple welded to extruded outlet
NT	MNPT nipple welded to float chamber
NSE	Flat end nipple for SW welded to extruded outlet
NS	Flat end nipple for SW welded to float chamber
NBE	Beveled end nipple for BW welded to extruded outlet
NB	Beveled end nipple for BW welded to float chamber
CT	FNPT half coupling
CS	Socket weld half coupling
WO	Weld-o-let ⁵
SO	Soc-o-let ⁸
TO	Thread-o-let ⁹

Top and bottom mounted option codes	
TF	Flange ⁹
TFS	Flange with removable stilling well
TP	MNPT plug ⁹
TPS	MNPT Plug with integral stilling well

Notes:

1. Float stop springs are standards in all alloy JMG's.
2. Standard for non flanged float chamber top or bottom closure. Butt weld caps can be specified; however, the weld root cannot be ground smooth on the i.d. leaving potential for float interference in the event of excessive float stop spring compression.
3. Extruded outlets are preferred for maximum performance of the float chamber. Available on all Sch. 10 SS gauges and some Sch. 40 SS gauges depending on max. pressure.
4. Use with carbon steel flanges, cryogenic insulation and when extruded outlet does not meet code as determined by factory.
5. Sch 40 minimum chamber thickness. This option will be selected by the factory when FE or FP do not meet code based on design pressure & temperature.
6. Piping engineers prefer this connection type; however, it is not preferred by the factory because it is difficult to manufacture the float chamber so that the float moves smoothly along the entire length.
7. Use this option when side process connection flanges larger than 2" NPS are required.
8. Sch. 40 minimum chamber thickness.
9. If the measuring length is greater than 24" or if turbulent conditions exist a customer supplied stilling well is needed.

MODEL NUMBER GUIDE

JMG Magnetic Level Gauge and JXC External Chamber

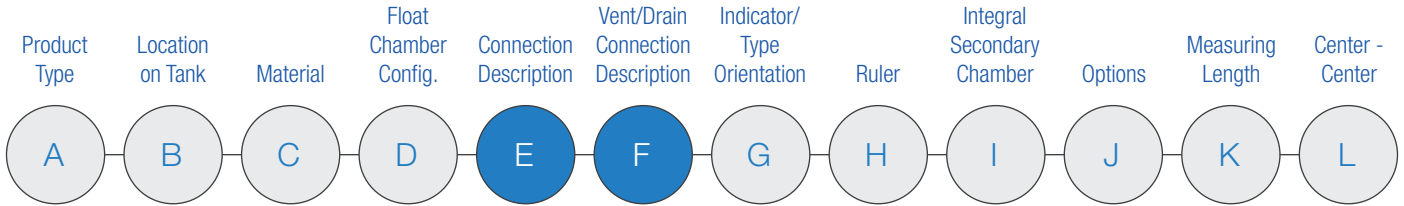

E | Connection description

Connection size code:	
5	1/2"
7	3/4"
1	1"
15	1-1/2"
2	2"
3	3"
4	4"

Connection rating/schedule code:	
Flange rating:	
1	150#
3	300#
6	600#
9	900#
15	1500#
25	2500#
Nipple, W-O-L, S-O-L, T-O-L Schedule:	
4	40
8	80
16	160
Half Coupling, Hex Plug Rating	
30	3000#
60	6000#

Flange face type (leave blank for nipples, half couplings and O-lets)	
Flange face:	
R	Raised face
L	Lap joint
T	RTJ
C	Other specify
S	Stub end with loose flange
F	Flat face

F | Vent/drain connection description

Connection size code:	
5	1/2"
7	3/4"
1	1"
15	1-1/2"
2	2"
3	3"
4	4"

Blank	Leave blank for no vent/drain connection or for 1/2" FNPT vent/drain connection
-------	---

Connection rating/schedule code:	
Flange rating:	
1	150#
3	300#
6	600#
9	900#
15	1500#
25	2500#
Nipple, W-O-L, S-O-L, T-O-L Schedule:	
4	40
8	80
16	160
Half Coupling, Hex Plug Rating	
30	3000#
60	6000#

Flange face type (leave blank for nipples, half couplings and O-lets)	
Flange face:	
R	Raised face
L	Lap joint
T	RTJ
C	Other specify
S	Stub end with loose flange
F	Flat face

Notes:

- 1/2" or 3/4" NPT vent/drain connections are standard. Larger sizes may require high hub blind flanges which increase price.

MODEL NUMBER GUIDE

JMG Magnetic Level Gauge and JXC External Chamber

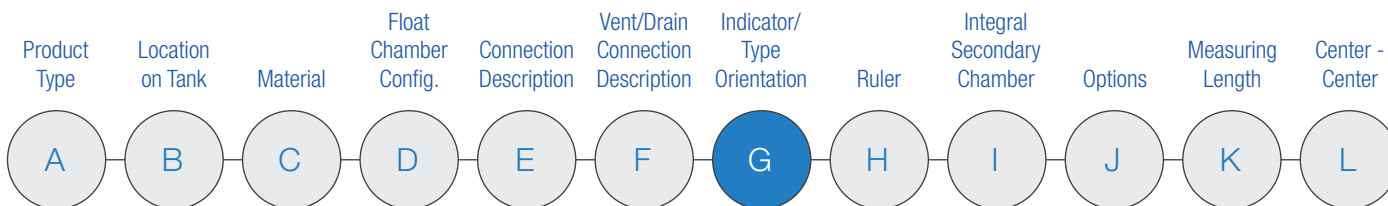

G | Indicator type/orientation

Indicator type code:		
Blank	No indicator for JXC external chamber	
STP	Standard width single tracker / shuttle type indicator with polycarbonate tube	350°F / 177°C max
STG	Standard width single tracker / shuttle type indicator with glass tube	450°F / 232°C max
STH	Standard width high temp single tracker / shuttle indicator with glass tube	1000°F / 538°C max
SF1P	Standard width yellow/black magnetic bargraph indicator with polycarbonate tube	350°F / 177°C max ^{2,3,4}
SF1G	Standard width yellow/black magnetic bargraph indicator with glass tube	550°F / 288°C max ^{2,3}
SF2P	Standard width red/white magnetic bargraph indicator with polycarbonate tube	350°F / 177°C max ^{2,3,4}
SF2G	Standard width red/white magnetic bargraph indicator with glass tube	550°F / 288°C max ^{2,3}
SFCP	Standard width magnetic bargraph indicator with polycarbonate tube. (Specify color.)	350°F / 177°C max ^{2,3,4}
SFCG	Standard width magnetic bargraph indicator with glass tube. (Specify color.)	550°F / 288°C max ^{2,3}
WF1P	Wide yellow/black magnetic bargraph indicator with polycarbonate tube.	450°F / 232°C max ⁴
WF2P	Wide red/white magnetic bargraph indicator with polycarbonate tube	450°F / 232°C max ⁴
WFCP	Wide magnetic bargraph indicator with polycarbonate viewing window. (Specify color.)	450°F / 232°C max ⁴

Indicator orientation code:	
Blank	Standard 6 o'clock position ⁵
3	3 o'clock position ⁵
9	9 o'clock position ⁵
C	Custom (specify)

As viewed from above

Notes:

- Maximum temperatures specified above are process temperatures.
- Add H to end of indicator type code for an insulation pad behind the indicator to increase max process temperature by 200°F / 93°C.
- Add IH to option code below to increase max process temperature by 250°F / 121°C for polycarbonate and 350°F / 177°C for glass.
- Add F to end of indicator type code for a frost extension for cryogenic service.
- Position is looking down on the gauge from above with side connections at 12 o'clock. Can be changed in the field on uninsulated gauges.

MODEL NUMBER GUIDE

JMG Magnetic Level Gauge and JXC External Chamber

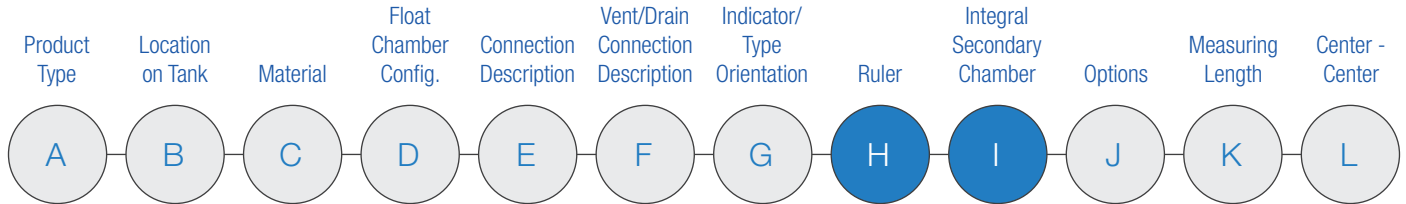

H | Ruler

Blank	No ruler for JXC external chamber
N	No ruler
F	Feet and inch with 1/2" divisions
I	Inches with 1/2" divisions (laser etched SS)
I8	Inches with 1/8" divisions (laser etched SS)
M	Meter and centimeter with 1 cm divisions
P	Percent (laser etched SS)

V	Volume (laser etched SS, specify units and graduation layout)
D	Dual scale (laser etched SS, specify types)
C	Custom (specify)

I | Integral chamber configuration code

Secondary chamber configuration code:	
Blank	Leave blank for no integral secondary chamber or for JXC external chamber. Select chamber size and top connection code only for JXC.
A	Flat pipe cap with FNPT threaded connection on top and 90 deg elbow on bottom ¹
B	Flange on top and 90 deg elbow on bottom ¹
D	Flat pipe cap on top and bottom with FNPT threaded connection on top and FNPT threaded drain connection with hex plug on bottom
E	Flange on top and flat pipe cap with FNPT threaded drain connection with hex plug on bottom
C	Custom specify

Top connection code:	
N5	1/2" FNPT ²
N7	3/4" FNPT ²
N1	1" FNPT ²
N15	1-1/2" FNPT ²
N2	2" FNPT ²
S5	1/2" female socket weld ²
S7	3/4" female socket weld ²
S1	1" female socket weld ²
S15	1-1/2" female socket weld ²
S2	2" female socket weld ²
F __	Flange. Use flange rating and face codes from "e" above.
C	Custom (specify)

Chamber size:	
15	1-1/2" standard
2	2"
3	3"
4	4"
C	Custom specify

Drain connection code	
Blank	No drain connection ³
N5	1/2" FNPT with 3000# hex plug
N7	3/4" FNPT with 3000# hex plug
N1	1" FNPT with 3000# hex plug

Orientation:	
3	3 o'clock ⁴
6	6 o'clock
9	9 o'clock

Notes:

1. Only available with 1.5" and 2" secondary chamber size. 2" available on all s/10 JMG's. 2" available on some s/40 and heavier wall JMG's (consult factory).
2. Use these codes for A and D chamber configuration codes only.
3. Secondary chamber configuration code A & B are not available with drain connections.
4. Orientation can not be same as indicator.

MODEL NUMBER GUIDE

JMG Magnetic Level Gauge and JXC External Chamber

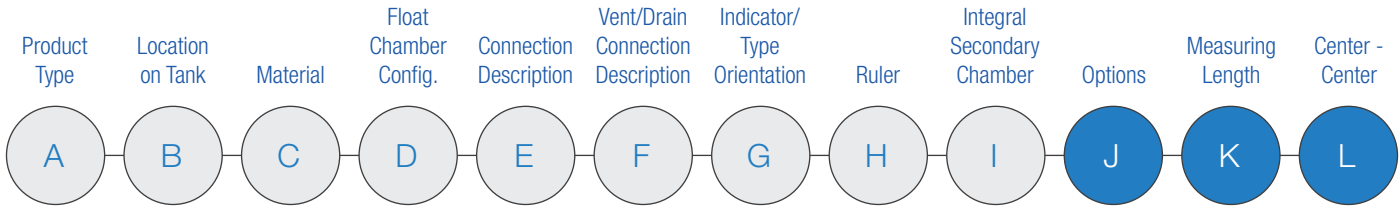

J | Options

Chamber options:	
WN	Weld neck flanges only
S4	Sch 40 minimum chamber thickness ¹
NE	No extruded outlets
IF	Interface level indication
DI	Total and interface level indication (ST indicator only)
G	Support gussets on side connections (long gauges or gauges in high vibration service)
OC	Oversize chamber with guide rods for flashing service
SR	Switch mount rod for gauges with high temperature insulation and switches.
AC	Auxiliary connections for DP cell, gauge glass, displacer or other secondary device. (Specify connection type and location)
PC	Powder coated
BA_	Adjustable support bracket (qty in blank)
BW_	Support bracket welded to chamber (qty in blank and provide location)

Insulation options:	
IH	High temperature insulation for chamber only
IHF	High temperature insulation for chamber and top/bottom flanges
CI	Cryogenic insulation for chamber and top/bottom flanges

Valve options:	
DV	Drain valve (specify type)
VV	Vent valve (specify type)
VDV	Vent and drain valves (specify type)
IV	Isolation valves (specify type)

Heating options:	
ST	Steam trace tubes (2 @ 3/8" x .035 316 SS)
HT1	Electric heat tracing for freeze protection. General purpose area classification.
HT2	Electric heat tracing with fixed setpoint control. 35, 45, 60, 90 or 180 deg F. Class I, Div. 2, Groups B, C, D.
HT3	Electric heat tracing with adjustable setpoint control. 300°F max. Class I, Div. 2, Groups B, C, D.
HTXP	Electric heat tracing with adjustable setpoint control. 700°F max. Class I, Div. 1, Groups C, D.
HTC	Custom Electric Heat Tracing

K | Measuring Length

Specify required measuring length. Usually the same as C-C on side/side connected gauges.

L | Center - Center, C-F, F-C or F-F

C-C	Leave blank if C-C is same as measuring length on side/side connected gauges.
C-F	Specified by factory on top-side/bottom connected gauges depending on float length.
F-C	Specified by factory on top/bottom-side connected gauges depending on float length.
F-F	Specified by factory on top/bottom connected gauges depending on float length.

Notes:

- Sch 10 is the standard. Chamber thickness (Sch 10 to Sch 160) will always be designed by the factory to meet ANSI B31.3 or B31.3 as applicable.
- The factory will select the float chamber diameter and thickness to meet the design conditions. Sch 10 is used if it meets the design pressure and temperature.

COMMON CHAMBER CONFIGURATIONS/CODES

JMG/S

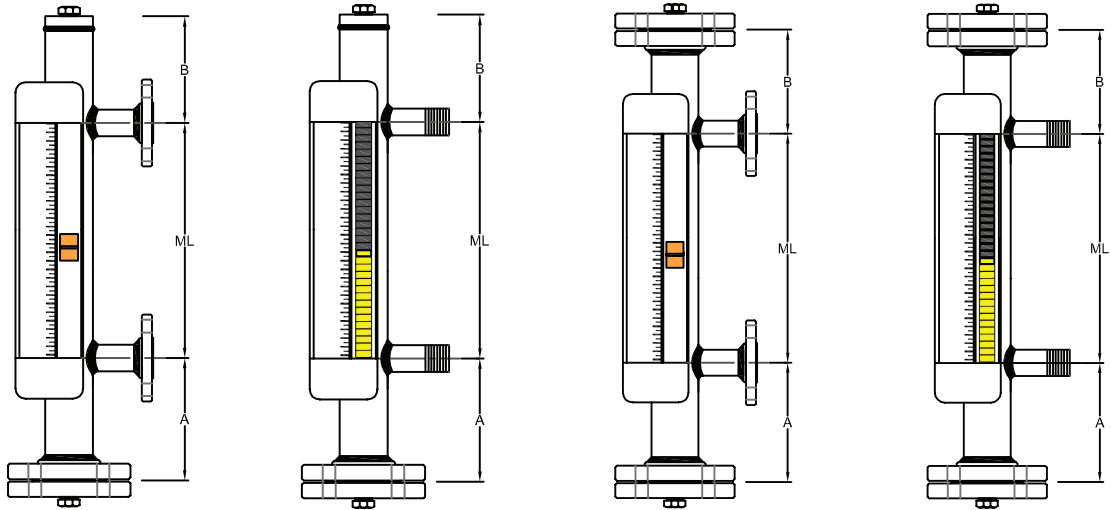

P2FPF2

P2NTNF2

F2FPF2

F2NTNF2

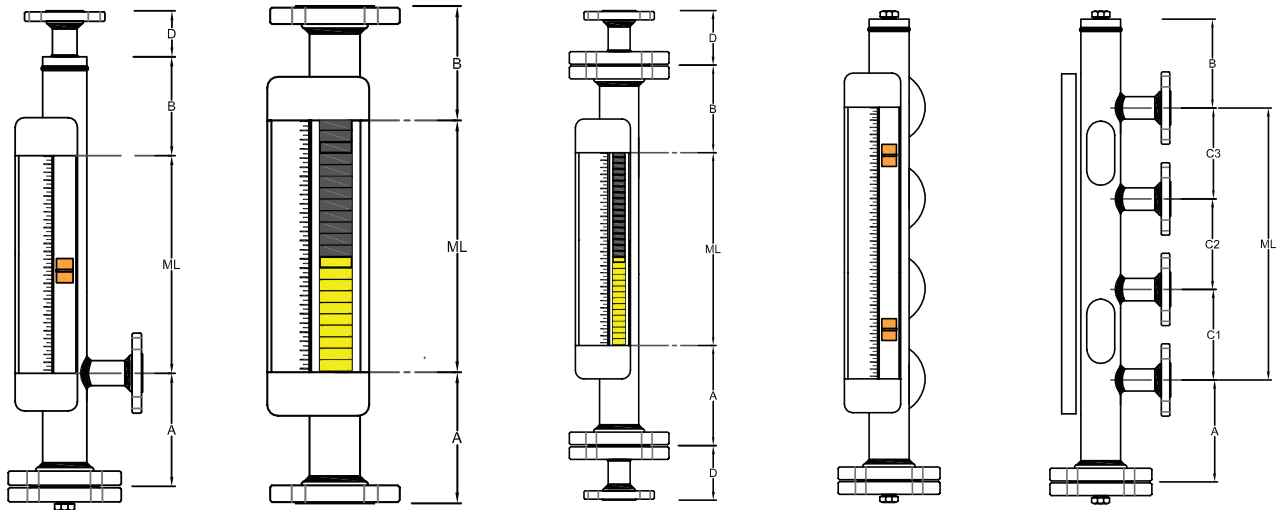

P7XPF2

FXXF

F7XFF

P24PF2

COMMON CHAMBER CONFIGURATIONS/CODES

JMG/S with Integral Secondary Chamber

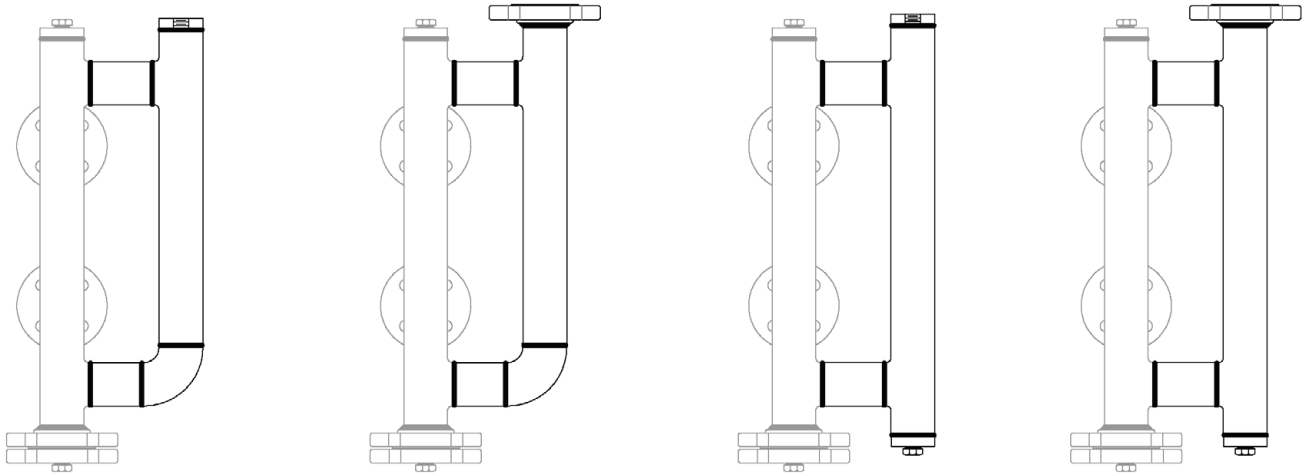

A

B

D

E

These codes are for the secondary chamber only.

TYPICAL INSTALLATION AND CONFIGURATION CODES

JMG/T | Typical installation

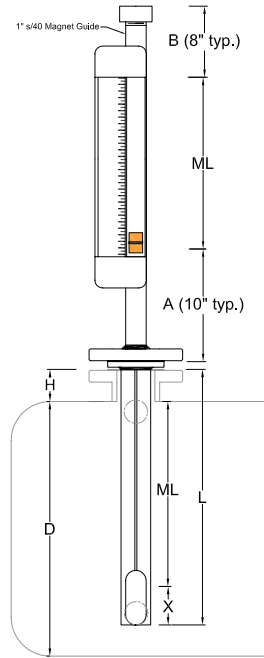

JMG/T | Configuration codes

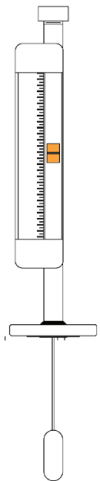

TF

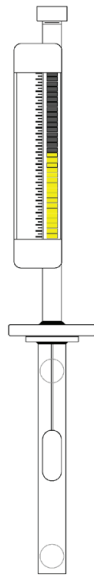

TFS



TP

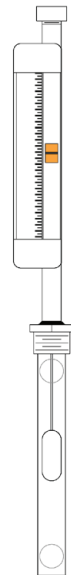

TPS

COMMON CHAMBER CONFIGURATIONS/CODES

JXC External Chamber for Direct Insertion Transmitter or Switch

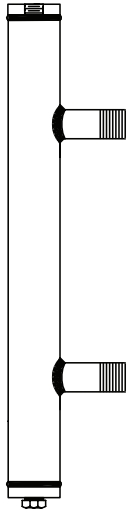

P1NTNP2

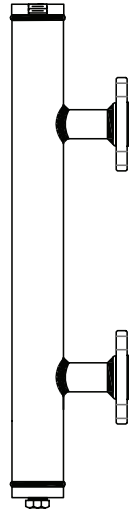

P1FFPP2

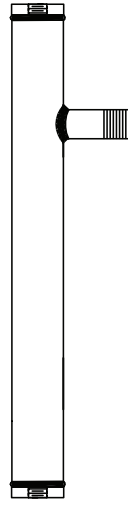

P1NTP1

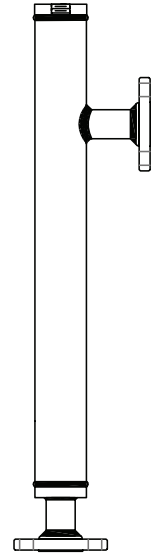

P1FPX7

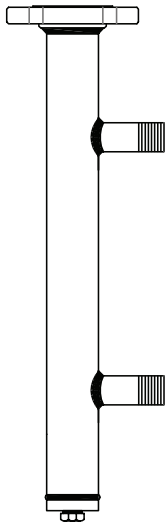

F1NTNP2

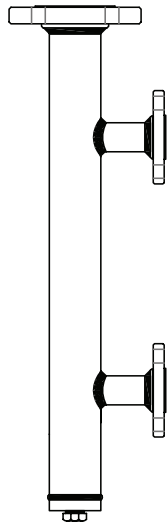

F1FFPP2

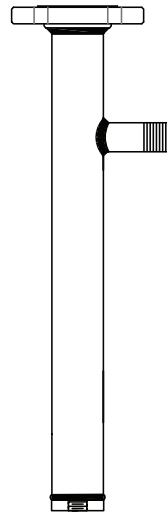

F1NTP1

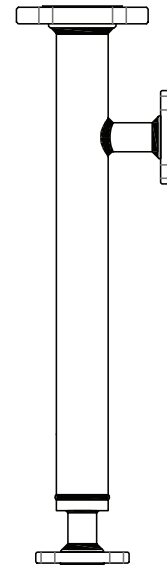

F1FPX7



MAGNETIC LEVEL GAUGE SPEC. SHEET

Side Mounted

Project:	
Customer:	
Location:	

Service Conditions	
Tag No.	
Vapor/Liquid, Interface, Both	
Fluid	
Lower Fluid (if interface)	
Fluid S.G.	
Lower Fluid S.G. (if interface)	
Min. Fluid S.G.	
Temp. Operating/Max.	
Minimum Design Metal Temp.	
Pressure Operating/Max.	
Special Conditions: High Vibration, Flashing, other	
Materials/Connections/Rating	
Chamber Material	
Flange Material	
Float Material	
Configuration (code # to right or sketch)	
Connection Size/Type/Rating	
Measuring Length / C-C	
Vent & Drain Connection	
Vent/Drain Valves (Size, Type, MFR)	
Indicator	
Type: Shuttle/Std Bargraph/Wide BG	
Bargraph Color: Yel./Blk., Red/White	
Ruler: Ft/Inch, Inch, m/cm, %, Special	
Location: 3, 6 (std), 9	
Transmitter	
Tag No.	
Mounting: Bottom or Top Elect.	
Area Classification:	
Location: 3, 6, 9 (std)	
Model #:	
Switches	
Quantity	
Tag Nos.	
Rating: Volts	
Amps (1,3,10):	
Form: SPDT, DPDT	
Terminal Housing: Yes, No	
Area Classification	
Model #:	

Other Options:	
Insulation: High Temp or Cryogenic	
Steam Trace Tubes	
Elect. Tracing: Freeze Prot. or Temp. Maint.	Required Maint. Temp.:
	Area Classification:
Other options:	
Model #:	

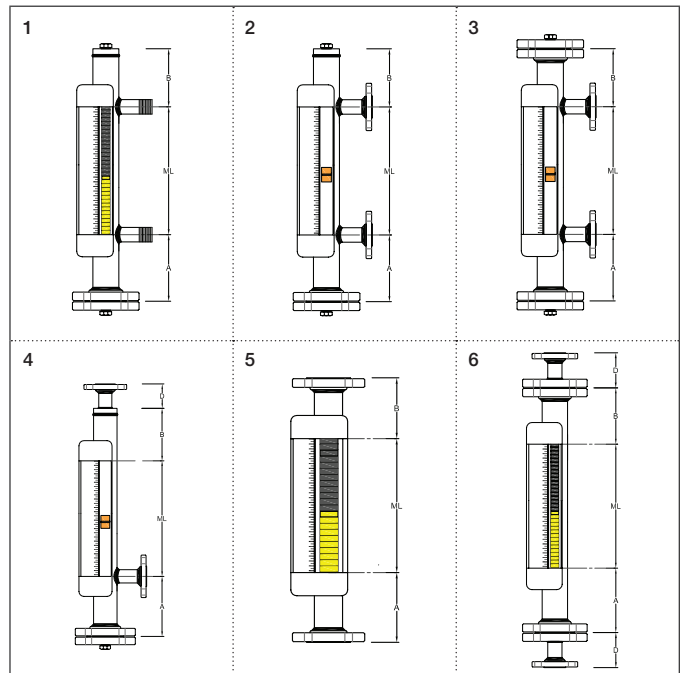

Sketch if different from above configurations:	
Indicator and Transmitter Location As viewed from above	



MAGNETIC LEVEL GAUGE SPEC. SHEET

Top Mounted

Project:

Customer:

Location:

Service Conditions

Tag No.
 Vapor/Liquid or Interface
 Fluid
 Lower Fluid (if interface)
 Fluid S.G.
 Lower Fluid S.G. (if interface)
 Min. Fluid S.G.
 Temp. Operating/Max.
 Minimum Design Metal Temp.
 Pressure Operating/Max.
 Special Conditions: High Vibration, Flashing, other

Materials/Connections/Rating

Tank Connection: Flange or Hex Plug
 Chamber Material
 Tank Connection Material
 Stilling Well Material
 Float Material
 Configuration (code to right or sketch)
 Connection Size/Type/Rating
 Measuring Length
 Nozzle Height (H)
 Tank Depth (D)

Indicator

Type: Shuttle/Std Bargraph/Wide BG
 Bargraph Color: Yel./Blk., Red/White, Other color
 Ruler: Ft/Inch, Inch, m/cm, %, Special

Transmitter

Tag No.
 Mounting: Bottom or Top Elect.
 Area Classification:
 Model #:

Switches

Quantity
 Tag Nos.
 Rating: Volts
 Amps (1, 3, 10)
 Form: SPDT, DPDT
 Terminal Housing: Yes, No
 Area Classification
 Model #:

Other Options:

Insulation: High Temp or Cryogenic

Other options:

Model #:

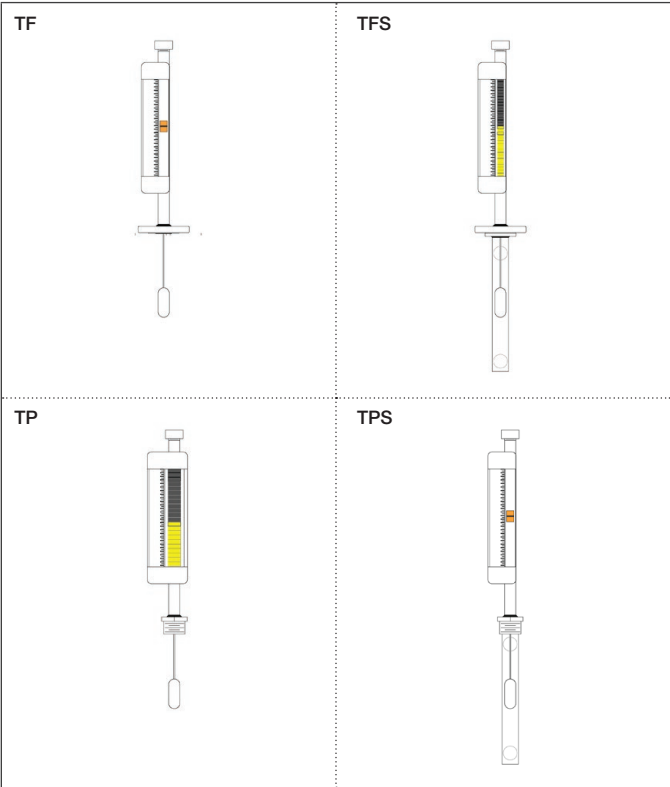

Sketch if different from above configurations:

Blank area for custom sketches or configurations.



CONTACT US

6646 COMPLEX DRIVE
BATON ROUGE, LA 70809
PHONE: 225-456-2495

TOLL FREE: 1-800-223-8469
INQUIRIES@JOGLER.COM

WWW.JOGLER.COM

